

# PLAIN

Thickness	110 mm / 140 mm / 155 mm
Length	Maximum 8 ft.
Width	2'6" / 3' / 3'6" / 4'
Customization	Permissible within the Maximum Lengths

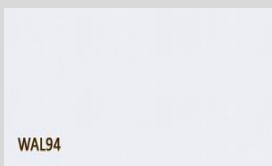

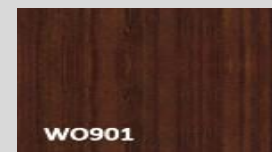
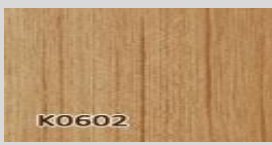
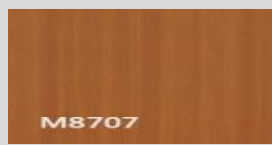
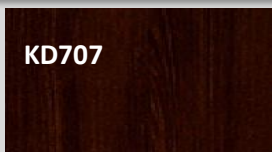
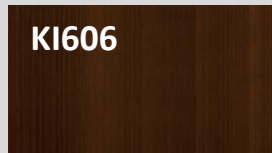
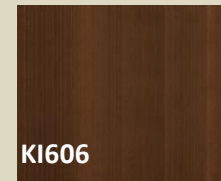

**KSD 102**

**Thickness**

**110mm**

**Length**

**Maximum 8 ft.**

**Width**

**2'6" / 3' / 3'6"**

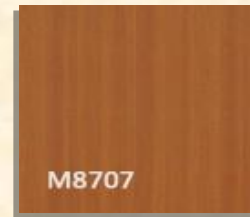
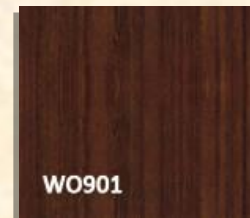
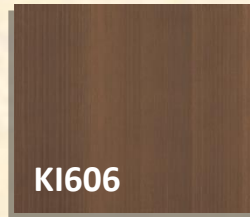
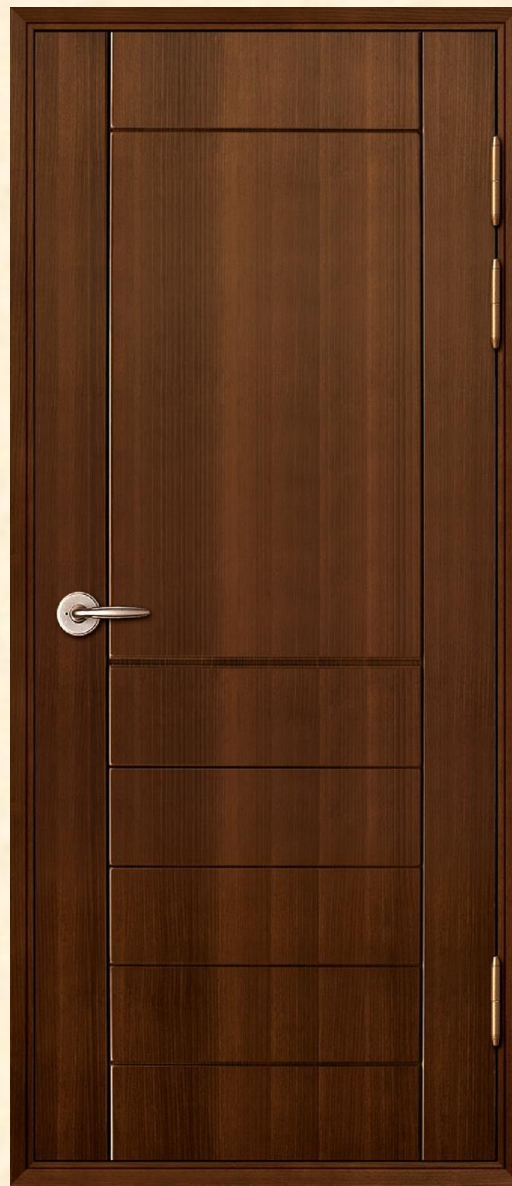

# KSD 105

**Thickness**

**110mm**

**Length**

**Maximum 8 ft.**

**Width**

**2'6" / 3' / 3'6"**

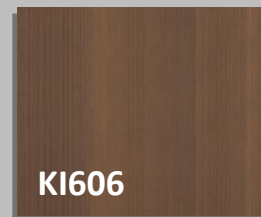
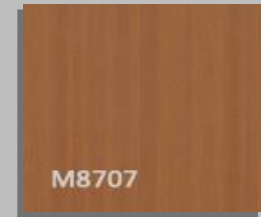

# KSD 110

Thickness 110mm

Length Maximum 8 ft.

Width 2'6" / 3' / 3'6"

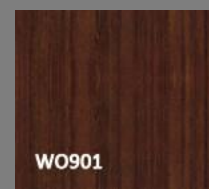

W0901

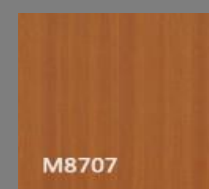

M8707

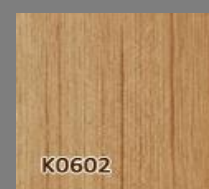

K0602

# KSD 111

Thickness 110mm

Length Maximum 8 ft.

Width 2'6" / 3' / 3'6"



W0901



M8707



K0602

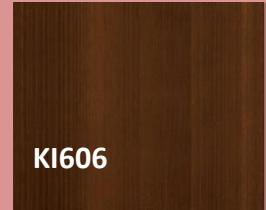

K1606

# KSD 112

**Thickness** 110 mm / 140 mm / 155 mm

**Length** Maximum 8 ft.

**Width** 2'6" / 3' / 3'6" / 4'

# KSD 113

<b>Thickness</b>	110 mm / 140 mm / 155 mm
<b>Length</b>	Maximum 8 ft.
<b>Width</b>	2'6" / 3' / 3'6" / 4'
<b>Customization</b>	Permissible within the Maximum Lengths



KI606

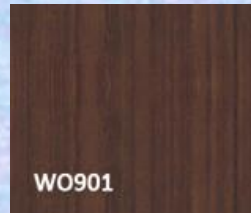

WO901

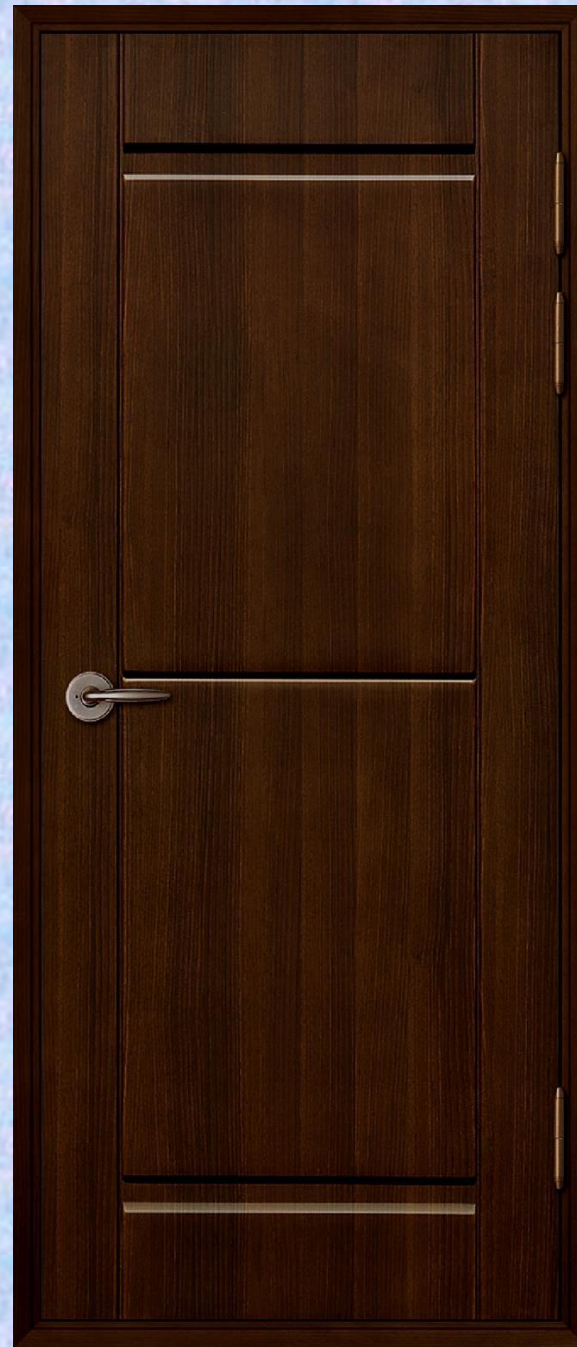



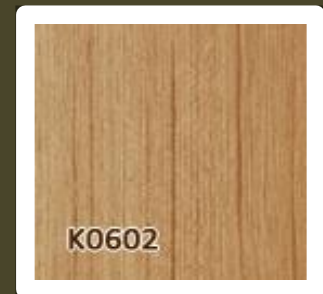
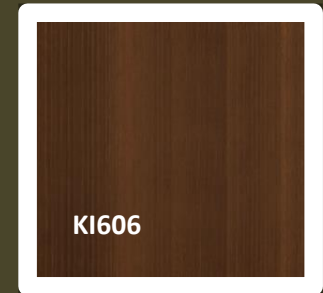
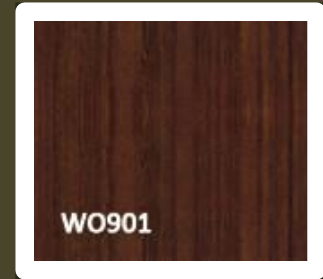
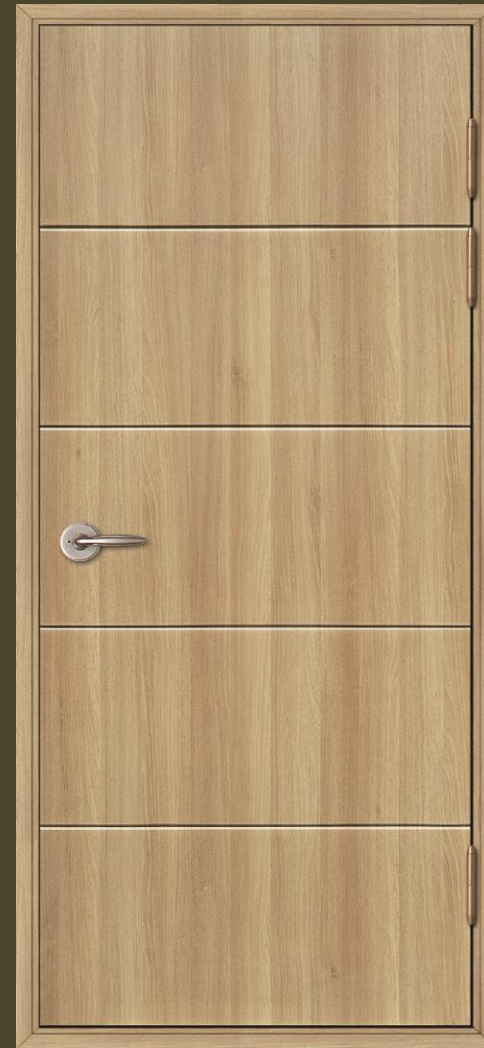

**KSD 114**

**Thickness**

**110mm**

**Length**

**Maximum 8 ft.**

**Width**

**2'6" / 3' / 3'6"**

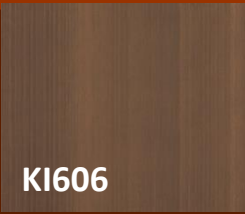

**KSD 115**

**Thickness 110mm**

**Length Maximum 8 ft.**

**Width 2'6" / 3' / 3'6"**

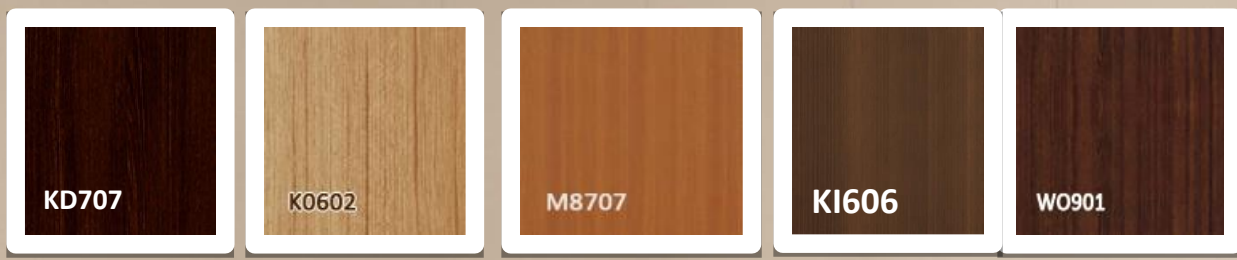

# KSD 116

Thickness	110mm		
Length	Maximum 8 ft.	Width	2'6" / 3' / 3'6"

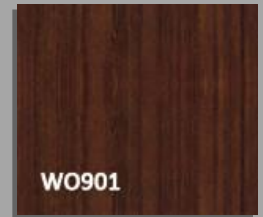
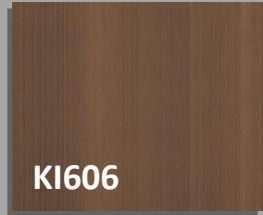

**KSD 201**

**Thickness 110mm**

**Length Maximum 8 ft.**

**Width 2'6" / 3' / 3'6"**

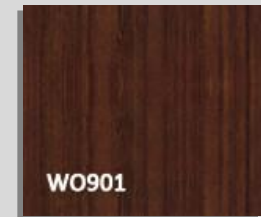
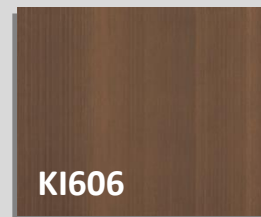
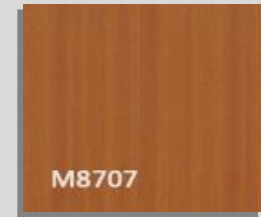

# KSD 202

**Thickness** 110mm

**Length** Maximum 8 ft.

**Width** 2'6" / 3' / 3'6"



**KSD 203**

**Thickness 110mm**

**Length Maximum 8 ft.**

**Width 2'6" / 3' / 3'6"**

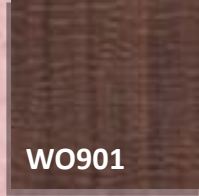
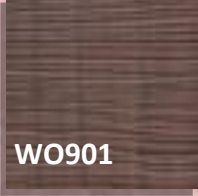

WO901

WO901

WAL94

WAL94

**KSD 501**

**Thickness 110mm**

**Length Maximum 8 ft.**

**Width 2'6" / 3' / 3'6"**

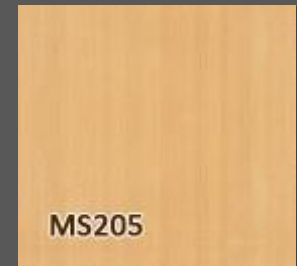

MS205



K1129

**KSD 502**

**Thickness**

**110mm**

**Length**

**Maximum 8 ft.**

**Width**

**2'6" / 3' / 3'6"**





WAL94



K0602

**KSD 503**

**Thickness 110mm**

**Length Maximum 8 ft.**

**Width 2'6" / 3' / 3'6"**

# DOOR FRAMES

# DOOR ARCHITRAVE



110 T

80 X 20  
DB



140 T

60 X 50  
DB



155 T



## ***UPVC WINDOWS***

**DURO**



**FENSTER**

UPVC Windows & Doors

A Product of  
**SPAN AND STRUCTURES**

# TWO TRACK SLIDING DOOR



# THREE TRACK SLIDING DOOR

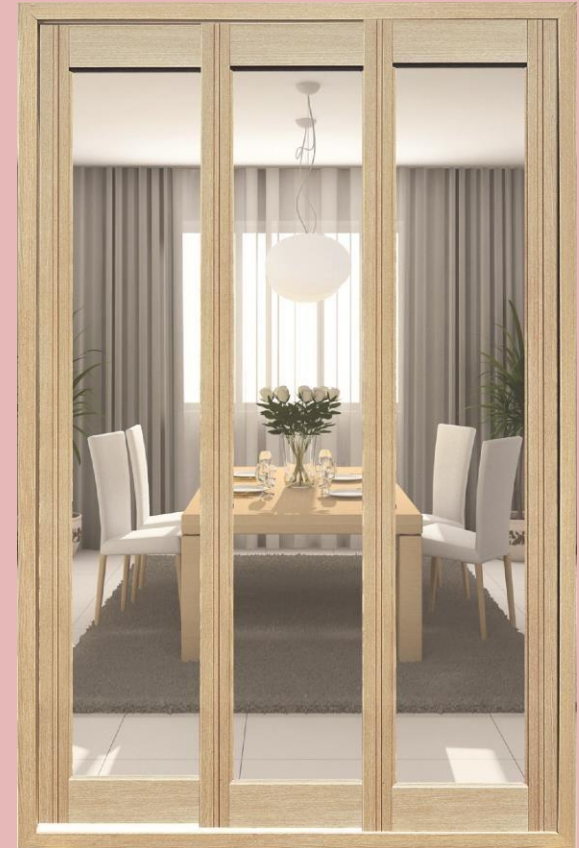

# OPEN TYPE WINDOW



# SLIDING WINDOW



# FRENCH WINDOW (4 SHUTTER)





**DURO FENSTER**  
is product of  
SPAN AND STRUCTURES



#332, Darus Salam Building,  
Basement Floor, Queens Road,  
Bangalore-560051. INDIA  
E-mail : [spanandstructures@gmail.com](mailto:spanandstructures@gmail.com)  
Web : [spanandstructures.com](http://spanandstructures.com)  
Mob : +91 93412 35788 | 77604 40587 | 87624 04104  
Off : 080 - 2226 2786

**CASEMENT WINDOW SYSTEM**

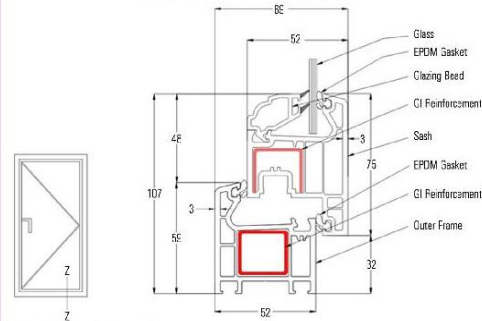

NOTE: All measurements are in MM  
**Cross Section of Outside Openable Window**

**SLIDING DOOR SYSTEM**

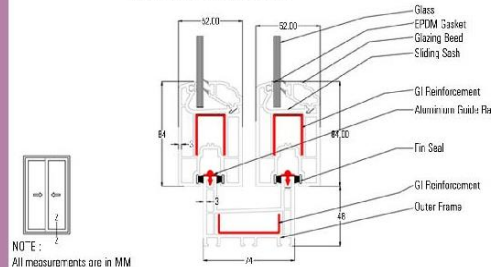

NOTE: All measurements are in MM  
**CROSS SECTION OF SLIDING DOOR WITHOUT MESH**



Sliding Window



**SLIDING WINDOW SYSTEM**

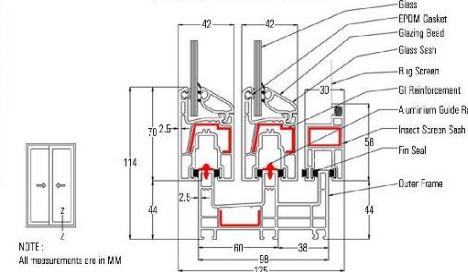

NOTE: All measurements are in MM  
**CROSS SECTION OF SLIDING WINDOW WITH MESH**

**Maintenance**  
**FREE Longlasting**



**D**URO FENSTER Systems are manufacturer and distributor of UPVC windows and doors located at Bangalore, India. UPVC means unplasticized poly vinyl chloride, DURO FENSTER systems specialized in designing different types of windows and doors with amazing ranges of UPVC Windows and UPVC Door systems.

It creates a hint of elegance nurtured with the tip of artistry which suits Indian weather conditions and design standards which protects your living/working space from noise pollution dust and rain.

DURO FENSTER UPVC windows and doors are well designed with heavy galvanized REINFORCEMENT steel that keeps it strong, fire resistant, dimensional accuracy, high quality standards and high-grade HARDWARE available at reasonable price and low maintenance, and we use high quality GLASS fitting for our UPVC Windows and Doors along with a leading upvc profile of \*Xinli. Customers will have customized designs on glass to get new look to their windows and doors.

DURO FENSTER UPVC windows and doors are most durable, sustainable and will last for many years. Perfecting the different manufacturing process has allowed us make a superior quality products suitable for any ambience. DURO FENSTER systems show expertise in technical designers, quality fabrication, team of trained professional installation, Custom designs.

DURO FENSTER UPVC windows and doors provide a perfect balance between energy efficiency and comfortable living. Your living/working space reflects best serene nature that will last for years. No more re painting and Anti-staining feature adds extra advantage while you just need to simply wipe and clean your UPVC windows which outshine the new ones.

Which are currently used in developed countries like Germany, Italy, Europe, China...Etc. Benefits of UPVC windows and UPVC doors:

### WHY DURO FENSTER WINDOW SYSTEMS?

DURO FENSTER is one of fastest growing upvc windows manufacturer . Its unique solutions comprise specially engineered designs that combine form with function better than anything you've ever seen. So every DURO FENSTER system is as stylish as it is ingenious, and as attractive as it is durable. For both practical and aesthetic reasons, DURO FENSTER ensures you of windows that work beautifully, taking care of a major factor in the success of any building project.

### QUALITY AND SERVICE DURO FENSTER

Our products are unrivalled in quality, technological innovation and exceptional design - bringing you all the benefits of modern UPVC doors and windows, including low maintenance, enhanced security, energy efficiency and lower costs.

At DURO FENSTER, our UPVC doors and windows systems are only supplied through a network of selected independent fabricators and installers, ensuring that you get the services of an experts local company backed by the resources of a Duro fenster origina-tions Together, we have created an unbeatable team - consistently delivering the best UPVC windows and doors available today.



Comparison chart			
Features	WOOD	Aluminum	UPVC
Thermal Resistance	Good	Bad	Very Good
Durability	Variable	Good	Excellent
Maintenances	High	Low	Very low
Convenience in installation	Tough	Reasonable	Very easy
Does it peel corrode ,rot, or wrap in bad weather?	Yes	Yes	Never
Does heat or cold transmit trough the material?	Yes	Yes	Never
Eco friendly	Poor	Good	Excellent
Aesthetics	Good	Fair	Excellent
Waste disposal	Recycling is difficult as profiles are treated with chemicals and various protective coatings.	Separation of aluminum coating parts is difficult	Up to 99% after separation from hardware and reinforcement
Fire retardant	Catches fire easily	Does not propagate fire	Does not propagate fire
Acoustic Insulation	Fair	Poor	Excellent
Does detergents and water cleaning make material look new again?	No	No	Yes

**DURO FENSTER UPVC** windows and doors system provide a perfect balance between energy efficiency and comfortable living. Your living/working space reflects best serene nature that will last for years.

### MILLIONS OF TREES DIE TO GIVE YOU PERFECT AMBIENCE.

Do you know it takes millions of trees to meet our furniture needs, which we choose precisely and custom make them according to our sense of taste. But , wait and think for a moment is there any thing we can do to stop this chop down of trees which gives us plenty of oxygen to breath- Yes!, there is one thing you can do; Use UPVC windows and doors instead of Wooden windows and doors as Most of the trees are used to make these windows and doors itself; Shift to Eco-Friendly Duro fenster uPVC Windows and Doors and be a part of our Green-Screen.

Duro Fenster ( a unit of Span And Structures)



**SHIRAM INSTITUTE FOR INDUSTRIAL RESEARCH**  
(A unit of Shiram Scientific and Industrial Research Foundation)  
An ISO - 9001:2008 Certified Institute

**TEST CERTIFICATE** 000370135

Issued To: Client Code: Y008  
YUJING INDIA PVT.LTD.  
411, 4TH FLOOR, R.E.D TRADE CENTER,  
BHOVA ROAD,  
GURGAON  
HARYANA, 122002

Date: 05/06/2015  
Job No.: 1000-1-01-2004  
Booking No.: 80251610069  
Booking Date: 21/05/2015  
Customer Ref No.: Nil  
Customer Ref Date: 21/05/2015

Sample Description: ONE SAMPLE DESCRIBED AS XINLI UPVC PROFILE

Sampling was carried out by Shiram Institute for Industrial Research. The sample details provided in the test certificate are based on declaration by the party.

S.No	Test	Result	Protocol
1	Fluorine Medium, Mpa	2007	As per ASTM D 790-07
2	Limiting Oxygen Index, %	49	As per ASTM D 2903-06
3	Water Absorption, %	0.65	As per ASTM D 559-06
4	Wear Softening Temperature, °C	80	As per ASTM D-1527-07
5	Thermal Conductivity, W/m.K	0.42	As per ISO-22007 Part-2
6	Colour Fastness (Artificial Weathering) (up to 100 cycle standard rating of 4)	Better than 4	As per ASTM G 155
7	Resistance to Impact by falling mass (100 gm ball at height of 2 meter)	Sample does not show rupture or broken	As per IS-4085-10
8	Behaviour after heat aging (At 70° for 16 hours)	No visible change is observed.	Using Oven
9	Dimension at 27°C, mm	1.08	As per ASTM D 790-08
10	Heat Resistance, %	1.0	As per IS-4085-10
11	Hardness (Shore D)	91	As per ASTM D 2240-05

DIGI E: 21 05 2015  
DIGI C: 06 06 2015

GC010rev04 Page 1 of 1

ATSHIRAM/SHIRAM/SHIRAM/EMPLOYEE CODE/000370135

19, University Road, Delhi - 110007. Ph: 91 81 2766787, 2766788, 2766789  
E-Mail: info@shiram.com Website: http://www.shiramindia.com Ph: 91 81 2766787, 2766788, 2766789

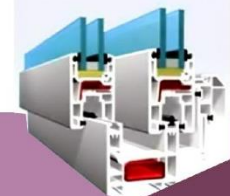

QR code

#332, Darus Salam Building,  
Basement Floor, Queens Road,  
Bangalore-560051. INDIA

E-mail : spanandstructures@gmail.com

Web : spanandstructures.com

Mob : + 91 93412 35788 | 77604 40587 | 87624 04104

Off : 080 - 2226 2786

# CONTACT

# DURO FENSTER

## UPVC Windows & Doors

### CONTACT INFO

#332, Darus Salam Building, Basement Floor, Queens Road, Bangalore-560051

Phone : +91-9341235788, +91-8762404104, +91-7760440587

Email : [info@durofenster.com](mailto:info@durofenster.com)

Website : [www.durofenster.com](http://www.durofenster.com)

Copyright © 2014 Duro Fenster All Rights Reserved.

*"A contact when established blossoms into relationship and we like to form such relationships."*